

Quick Install Guide

Indoor Wireless Access Point (Access 1200)

1. Network Topology

- A DHCP-enabled network (for the AP to obtain an IP address as well as for the wireless clients after deployment)
- For MESH network, MC or Cloud manager running as a Controller.

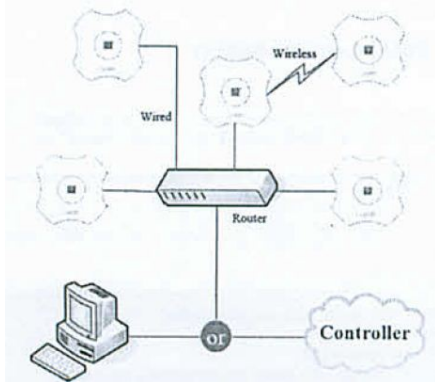

• After you have powered on the device, please check the LED status

Indicator	Name	Normal Status
	Power LED	continuously on
	WAN LED	continuously on
	LAN LED	continuously on/Flashing
	Signal Strength	Increases from left to right

2. Package Contents

- Quick Install Guide
- 24V 1A GE Passive PoE Adapter
- M3x20 Self Tapping Screw (Qty. 3) • M3x20 Screw Anchor (Qty. 3)
- M3x30 Flat Head Screw (Qty. 3)
- M3 Nut with Tooth Washer (Qty. 3)

3. Computer Configuration

Set your IP address to **192.168.1.100** and change the Subnet Mask to **255.255.255.0**

* The IP address of the computer can be any IP from **192.168.1.2** to **192.168.1.254**

Open the web browser. At the Address bar, enter the IP address of the access point **192.168.1.1** then press "Enter" on the keyboard.

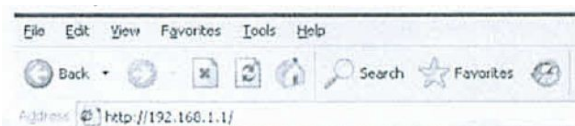

Enter the default user name and password

Username: **admin**

Password: **password**

* Remember to change your password for security purposes.

Download the User Manual and the latest firmware at:

<http://www.silvernet.com>

4. Mounting

Wall-Mount

Step 1. Align the Wall-Mount Bracket with the Wall Mount text facing up. There are horizontal and vertical lines on the bracket to help with orientation.

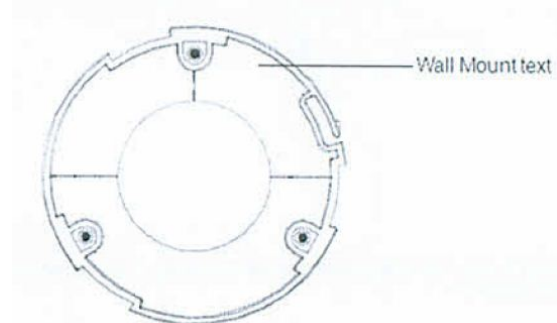

Step 2. Use a pencil to mark the holes on the wall.

Step 3. Use a 6mm drill bit to drill the holes in the wall.

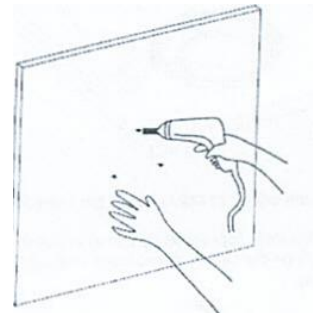

Step 4. Insert the 3 M3x20 Screw Anchors into the wall.

Step 5. Secure the Wall-Mount Bracket to the wall by inserting the M3x20 Self Tapping Screws into the anchors.

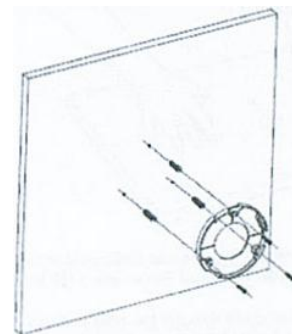

Step 6. Align the notches on the AP with the notches on the Wall-Mount Bracket.

Step 7. Turn the AP clockwise until it locks into place.

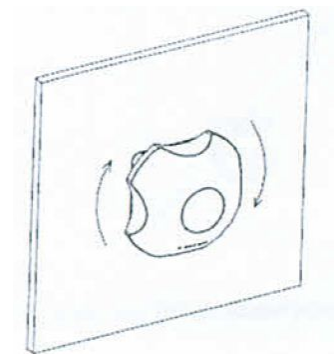

Ceiling-Mount

Quick Install Guide

Indoor Wireless Access Point (Access 1200)

Step 1. Remove the ceiling tile.

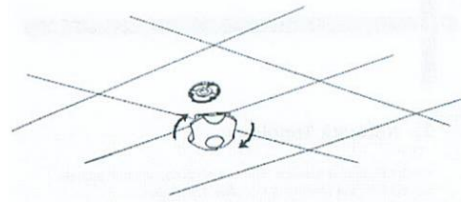
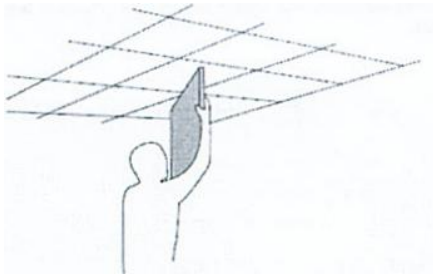

Step 2. Align the Ceiling-Mount Plate to the center of the top side of the ceiling tile.

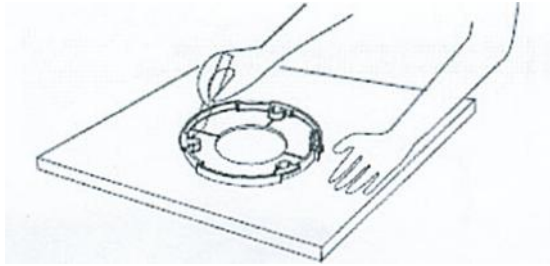

Step 3. Use a 3.5mm drill bit to drill holes for the three flat head screws.

Step 4. Cut or drill a circle approximately 25mm in size that lines up with the larger circle on the Ceiling-Mount Plate. This will be used for the Ethernet cables.

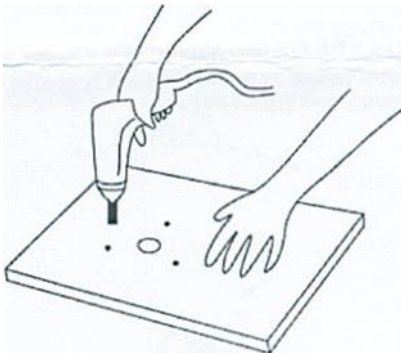

Step 5. Secure the Wall-Mount Bracket and Ceiling-Mount Plate to the ceiling tile using the 3 M3x30 Flat Head Screw and 3 M3 Keps Nut with Tooth Washer.

Step 6. Feed the Ethernet cable through the hole and then align the AP with the notches on the Wall-Mount

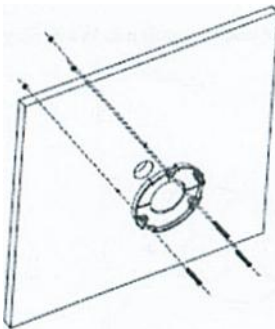

Note: The AP supports both 802.3af PoE and Passive PoE

Step 7. Turn the AP clockwise until it locks into place